

Alfa Laval LKH Prime Centrifugal Pump

The Premium Self-Priming Pump

Applications

The LKH Prime is a highly efficient self-priming pump, which meets the requirements of hygienic applications. The ability to evacuate air from the suction pipe combined with a low noise level and high pumping efficiency makes the LKH Prime ideal for tank emptying and CIP return applications. With verified effective CIP cleanability, LKH Prime can be used as a product pump as well.

Standard design

Based on the LKH, the LKH Prime is designed to be cleaned in place. The LKH Prime has a stainless steel shroud for protection of the motor, and the complete unit is supported on four adjustable stainless steel legs. Unlike conventional self-priming pumps the LKH Prime has an impeller which can be trimmed for any application.

Shaft seals

The LKH Prime is equipped with either an external single or a double mechanical shaft seal. Both have stationary seal rings made from stainless steel AISI 329 with sealing surface in silicon carbide and rotating seal rings in carbon as standard.



TECHNICAL DATA

Standard materials

Product wetted steel parts: W. 1.4404 (316L).
Other steel parts: Stainless steel.
Inside surface finish: Standard blasted.
Product wetted elastomers: EPDM.

Connections for double mechanical shaft seal

1/8" BSP.

Motor

Foot-flanged motor with a fixed angular contact bearing according to the IEC metric standard, 2 poles = 3000/3600 rpm at 50/60 Hz, IP 55 (with drain hole sealed with labyrinth plug), insulation class F.

Min/Max speed

Air evacuation: 2800 - 3600 rpm.
Pumping product (no air): 900 - 3600 rpm.

Warranty

Extended 3-years warranty on LKH Prime pumps. The warranty covers all non-wear parts on the condition that genuine Alfa Laval Spare Parts are used.

OPERATING DATA

Pressure

Max inlet pressure: 500 kPa (5 bar).

Temperature

Temperature range: -10°C to +140°C (EPDM).

Double mechanical shaft seal

Water pressure inlet: Max. 500 kPa (5 bar).
Water consumption: 0.25 - 0.5 l/min.

Dimensions

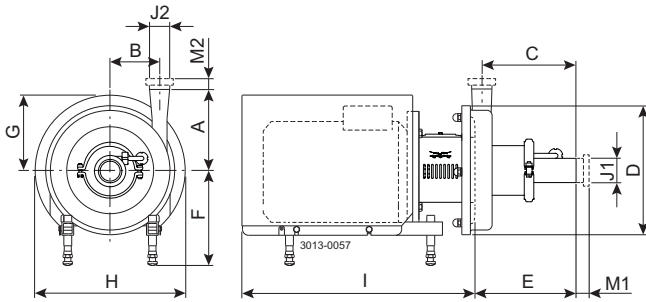

Pump specific measures

Pump Model	LKH Prime 20	LKH Prime 40
A	187	259
B	92	126
C	248	271
D	253	329
E	280	301

Motor specific measures

Motor							
IEC	IEC90	IEC100	IEC112	IEC132	IEC160	IEC180	IEC200
Motor							
kW	1.5/2.2	3.0	4.0	5.5/7.5	11-18.kw	22	30/37/45
F(max)*	262	282	285	304	332	352	372
G	157	185	198	196	262	286	399
H	288	325	359	383	485	533	670
I	434	516	497	597	791	842	980

*Possible to reduce dimension F by min. 59 mm for all pump models.
For smaller models it will be possible to reduce dimension F even further.

Motor overview

Pump Model	LKH Prime 20	LKH Prime 40
Motor range (IEC)	IEC90-IEC160	IEC132-IEC200

Dimensional data are based on 2 pole, ABB motors.

Connections

Pump Model	LKH Prime 20	LKH Prime 40
Clamp ISO 2037	M1	21
	M2	21
Union ISO(IDF)	M1	21
	M2	21
Union DIN/ISO	M1	25
	M2	22
Union SMS	M1	24
	M2	20
Union (BS)RJT	M1	27
	M2	27
Union DS	M1	24
	M2	20
Union DIN/DIN	M1	25
	M2	22
J1*	63.5 / 2.5"	76.1 / 3"
J2*	51 / 2"	63.5 / 2.5"

* Other dimensions available on request.

ESE03123EN/1

Flow chart

Frequency: 50Hz - Speed (synchr): 3000 rpm

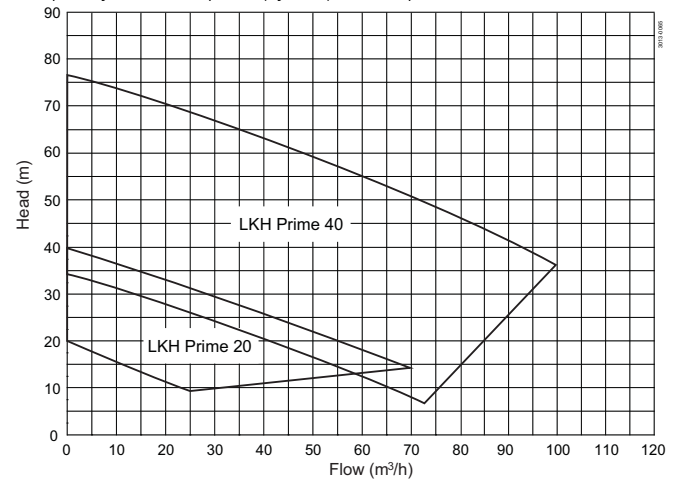

Options

- A. Impeller with reduced diameter.
- B. Motor with increased safety/flare proof motor.
- C. Double mechanical shaft seal.
- D. Product wetted surface finish $Ra \leq 0.8 \mu m$.
- E. Product wetted elastomers of Nitrile (NBR) or Fluorinated rubber (FPM).
- F. Rotating seal ring of Silicon Carbide.
- G. 1/2" tri clamp drain connections (two connections)

Ordering

Please state the following when ordering:

- Pump size.
- Connections.
- Impeller diameter.
- Motor size.
- Voltage and frequency.
- Flow, pressure and temperature.
- Density and viscosity of the product.
- Options.

Alfa Laval reserves the right to change specifications without prior notification.

How to contact Alfa Laval

Contact details for all countries are continually updated on our website. Please visit www.alfalaval.com to access the information direct.

